

Supports operability and the fineness of print-outs

RIP Software (Provided as standard)

Raster Link 7 *New!*



Average 25% increase in RIP processing speed

Raster Link 7



Raster Link 6 PLUS → 25% time reduction



■ Specifications

Item	JFX600-2513	
Head	On-demand piezo head 16 printheads arranged in 4 staggered lines for 4 heads	
Print resolution	600 dpi, 1200 dpi	
Ink	Type	Hard UV-curable ink LH-100
		Flexible UV-curable ink LUS-120/LUS-150 ¹
	Supply system	1 liter bottle for each ink
	Ink circulation system	White ink circulation using MCT (Mimaki Circulation Technology) ²
Maximum printable area (W × D)	2,500 × 1,300 mm	
Media	Size (W × D)	Up to 2,500 × 1,300 mm
	Height	60 mm or less
	Weight	50 kg/m ² or less
Media absorption	Blower absorption type + foot switch	
Absorbing area division number	Divided into 2 (X direction)	
UV unit	LED-UV system	
Interface	Ethernet 10GBASE-T	
Certifications	CE Mark (EMC Directive, Machinery Directive), UL775, RoHS, EAC, UKCA	
Power supply	(200-240VAC ±10% 50/60Hz ±1Hz, 24A) × 3	
Power consumption	INLET1-3, each INLET: 4,800W or less	
Operation environment	Temperature	20°C to 30°C
	Humidity	35 to 65% RH (No condensation)
	Guaranteed accuracy temperature	20°C to 25°C
	Temperature gradient	±10°C/h or less
	Dust level	0.15mg/m ³ (Equivalent to a general office floor level)
External dimensions (W × D × H)	Approx. 5,300 × 2,850 × 1,700 mm or less	
Weight	1,100 kg or less	

¹: The stretchability of flexible ink varies depending on the printing material. Please be sure to do a test print beforehand.
²: MCT works only with white ink.

■ Installation space

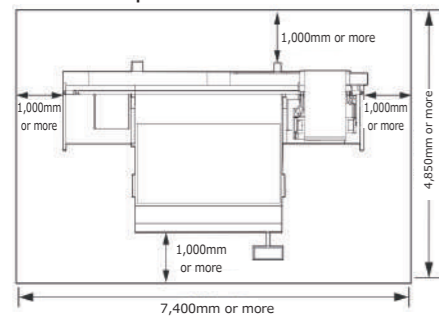

⚠ Inks and substrates:

As physical properties of ink (adhesion, weather resistance etc.) are different depending on media, please be sure to have a print test in advance.
Depending on the application, primers, other surface treatment or surface protection such as lamination may be necessary.

Some of the samples in this catalog are artificial renderings. Specifications, design and dimensions stated in this catalog may be subject to change without notice (for technical improvements, etc). The corporate names and merchandise names written on this catalog are the trademark or registered trademark of the respective corporations. Inkjet printers print using extremely fine dots, so colors may vary slightly after replacement of the printing heads. Also note that if using multiple printer units, colors could vary slightly from one unit to other unit due to slight individual differences.
The specifications described in this catalog are as of January 2022.

CMYUK

www.cmyuk.com sales@cmyuk.com

Automation of printing processes

Adaptable to "Mimaki Device Language (MDL)" to realize automation of printing processes

Using MDL commands allows you to automate printer control, job management, and workpiece conveying device operation from an external device

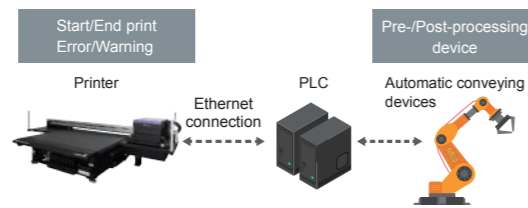

*When using MDL commands, refer to the separate MDL commands manual included in the SDK.
*Please note that machine failures due to MDL commands may not be covered by our warranty.

Safety devices to prevent trouble



Work status indicator light

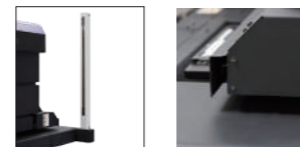

Intrusion prevention sensor for the operating area

Media jam sensor

■ Supplies

Item	Color	Item No.	Remark
LH-100 GREENGUARD Gold certified ink	Cyan	LH100-C-BA	1L bottle
	Magenta	LH100-M-BA	
	Yellow	LH100-Y-BA	
	Black	LH100-K-BA	
	Light Cyan	LH100-LC-BA	
	Light Magenta	LH100-LM-BA	
	White	LH100-W-BA	
LUS-120 GREENGUARD Gold certified ink	Cyan	LUS12-C-BA	1L bottle
	Magenta	LUS12-M-BA	
	Yellow	LUS12-Y-BA	
	Black	LUS12-K-BA	
	Light Cyan	LUS12-LC-BA	
	Light Magenta	LUS12-LM-BA	
	White	LUS12-W-BA	
LUS-150 ¹ GREENGUARD Gold certified ink	Cyan	LUS15-C-BA	1L bottle
	Magenta	LUS15-M-BA	
	Yellow	LUS15-Y-BA	
	Black	LUS15-K-BA	
	Light Cyan	LUS15-LC-BA	
Primer	PR-200	PR200-Z-BA	1L bottle

¹: If you use CL in the LUS-150 ink set, please use the CL of LH100.

For INDUSTRIAL PRODUCTS

Large Flatbed UV-LED Inkjet Printer

JFX600-2513

Mimaki

Product Brochure



⚠ Safety notice:

This product is equipped with UV irradiation equipment. Please pay attention to the following notes in order to use safely.
Do not look directly into the UV light source nor place your hand, or expose your skin directly to the UV light source.
Depending upon print mode, some VOC emissions from printed parts not yet cured and hardened may occur.
In addition, please be sure to read and follow the instructions and guidelines of the manual carefully.

Demonstration & Training Centre:

Unit 3B, Vanguard Way,
Battlefield Enterprise Park,
Shrewsbury, SY1 3TG. UK.

+44 (0) 1743 810000

Head Office:

Unit 3A Headley Park Ten,
Headley Road East,
Woodley,
Berkshire, RG5 4SW. UK.

+44 (0) 118 989 2929



JFX600-2513



Maximum print speed
200 m²/h*1

Equipped with
6 color inks

High speed and High quality

With a maximum print speed of 200 m²/h and 6-color ink printing, this printer is specially designed for high speed and high quality printing required for large format graphics printers, featuring three types of high-performance UV ink to choose from, a 4' x 8' size table (the most common size in the sign industry), MPC (touch-screen monitor connected to the printer), and safety devices. In addition, a printer control interface is provided for the operation automation.

*1: For JFX600-2513 at Draft mode, 4C, 600×600 dpi, 2P printing

Amazingly high productivity

Compared with the equivalent image quality print mode

Up to Max. 330% UP

Max. 330%² faster than the previous model (JFX500-2131) by installing significantly more printheads. The great increase in productivity allows for quick delivery of large format prints.

*2: Comparison between JFX600-2513 in Draft mode/4C/600×600 dpi/2P and JFX500-2131 in Draft mode/4C/300×450 dpi/3P

Speed comparison in the equivalent image quality, when printing at 4C / 1 layer

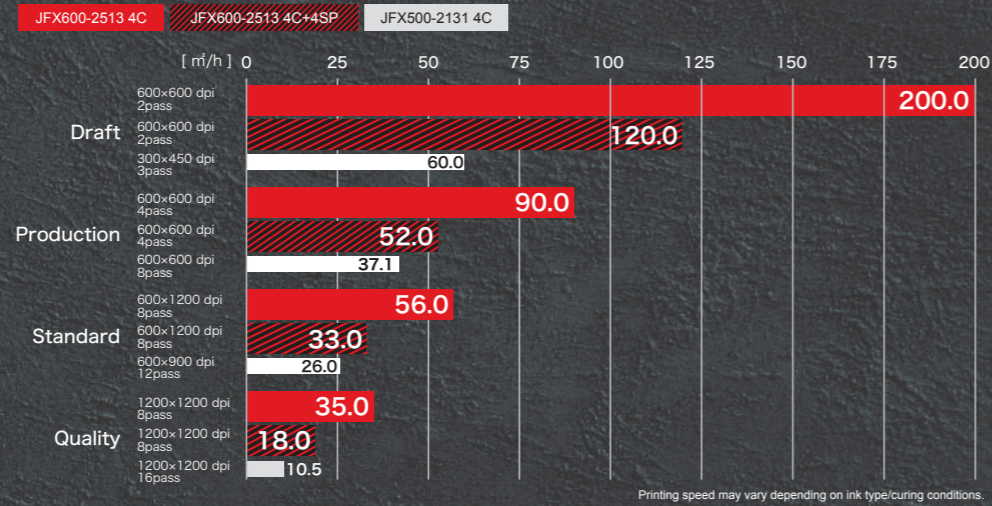

Six colors, including light colors, are supported *New!*

Ink color sets LH-100, LUS-120, LUS-150³

CCMYYKK



Four-color ink set for high productivity, achieving a fast print speed of 200 m²/h

CMYKcLmWW



Add light colors for smooth gradations, natural skin tones, and vivid photo reproduction⁴

CMYKWWCIPr



Use clear ink for gloss/matte finishes, embossing, and 2.5D print creating semi-stereoscopic surfaces, and primer for stronger adhesion between ink and material

Six colors, including Lc and Lm, are available for rich color expression. There are a wide variety of ink types to choose from to suit your application. Every ink has gained the "GREENGUARD Gold" certification by meeting VOC⁵ emissions requirements, the most stringent standard in the world, from UL, a U.S. third-party safety science organization, and is recognized for its environmental safety.



Type	Hard UV ink	Flexible UV ink	
Product	LH-100	LUS-120	LUS-150
Features	The LH-100 ink has a high scratch/chemical resistance and an accurate color reproducibility. The ink is suitable for rigid materials.	The LUS-120 ink has 170% stretchability after curing. Its ink film is very flexible and will not crack during post process.	The LUS-150 ink has 150% stretchability after curing and 150% stretchability after curing and will not crack during post process. This ink is compatible with a wide range of materials and has a low degree of tackiness.

*3: LH-100 and LUS-120 are to be supported later
*4: Light colors are to be supported later
*5: VOC = Volatile organic compound

Mimaki's image quality control technology ensures more beautiful prints

Waveform control

Thanks to Mimaki's unique advanced ink droplet ejection control, droplets with high circularity can be ejected to make them accurately land on the media. This enables sharp expression of text, ruled lines, and edges.

<Droplets ejected with low circularity>

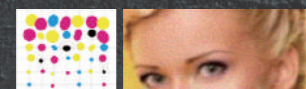

Spaced or overlapping dots make image quality rough and edges blurred.

<Droplets ejected with high circularity>

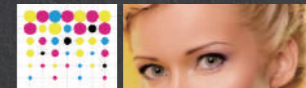

Droplets can be placed with high precision. It provides a sharp print finish with less graininess.

MAPS4 (Mimaki Advanced Pass System 4)

Banding (horizontal stripes), uneven color, and glossy streaks can be reduced to realize smooth prints by printing pass boundaries fading in gradation.

<Without MAPS4>



<With MAPS4>

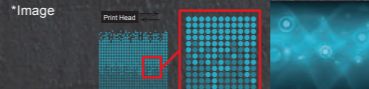

Based on printing conditions such as media/ink type and resolution, the most suitable gradation pattern is automatically selected and printed.

Variable dots

Three different ink dot sizes are used to enable high-quality prints with reduced graininess.

<Normal dots>



<Variable dots>

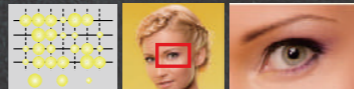

Combination of dots including the minimum size of 7pl enables grainless, smooth color printing.

MPC using a graphical user interface *New!*

MPC (Mimaki Printer Controller)

It is a new software used for operation in the touch screen monitor connected to the printer. All operations are visually organized by item and can be performed on the MPC screen, including setting print conditions, checking work/printer status and work history, and checking maintenance instructions.

Job management status

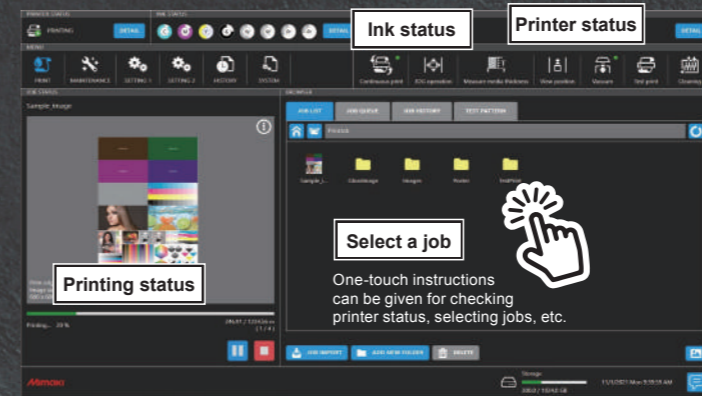

Printing conditions management status

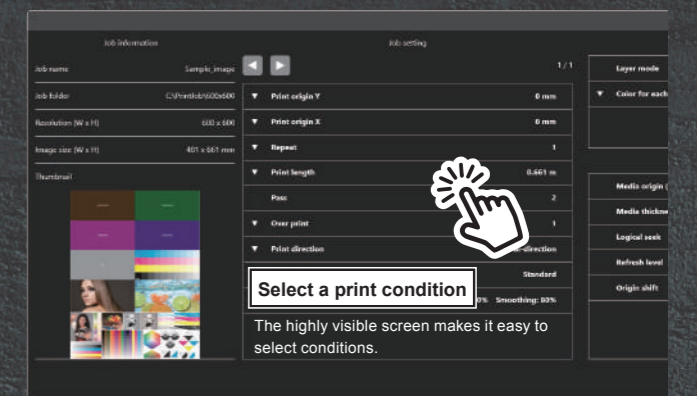

Designed with usability in mind

Table size & Vacuum table *New!*

The table size of 2,500 × 1,300 mm nicely fits commonly used 4' × 8' media. The vacuum area to hold media is divided into two sections in the X direction of the table, and can be adjusted to the media size you use by opening/closing valves. Besides the operation panel, a foot switch can be used to turn the vacuum on and off.



The vacuum area can be split

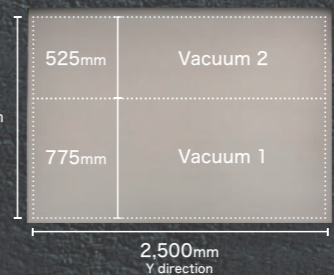

Supporting media as thick as 60 mm *New!*

Direct printing on media as thick as 60 mm allows you to expand the range of materials.

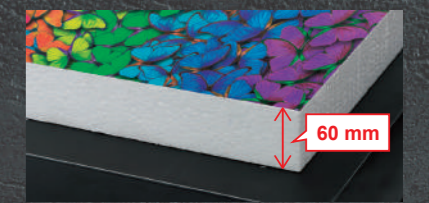

Reliable functions for stable operation

NCU (Nozzle Check Unit)

The sensor automatically detects the nozzle condition. When the NCU detects a missing nozzle, it automatically performs cleaning to solve the problem.

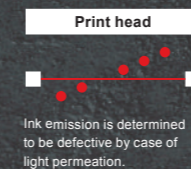

NRS (Nozzle Recovery System)

If there is a nozzle problem that cannot be solved by cleaning, it automatically replaces the defective nozzle with an alternate one for each nozzle, which enables continuous printing without lowering printing speed. The system is automatically controlled based on the information provided by the NCU. NRS may be unusable in some print modes.

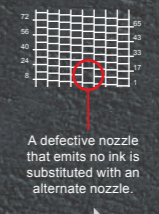

MCT (Mimaki Circulation Technology)

An ink circulation mechanism is provided in the ink tank and ink path. It circulates white ink periodically to prevent nozzle trouble due to deposited ink pigments and to stabilize printing performance.

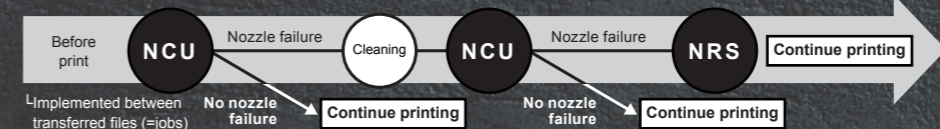
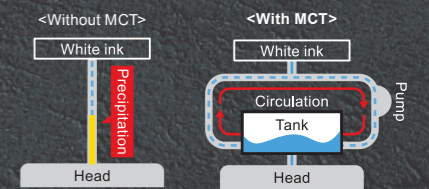

Variable expression to add more value to prints

2.5D Texture Maker

Multi-layered gradation data can be created by "2.5D Texture Maker", a function of the bundled RIP "RasterLink7".* Smooth expression of bumpy textures can be achieved using multiple layers of UV ink. This allows you to create realistic and eye-catching graphics.



White ink and clear ink

Printing together with high-concentration white ink as the base color on transparent or deep-color media makes full-color images more vivid. Clear ink printing enhances decorative effects such as mat, gloss and texture.

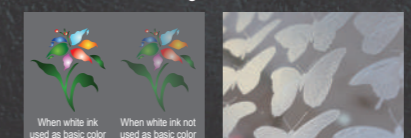

Inkjet primer

A primer that enhances ink adhesion to glass, metal, or surface-treated material. Because primer coating simultaneously with color printing is possible, the primer can be placed only on those portions requiring it. Placing primer only where it is required without manual work is possible, making the most of the texture of raw material and realizing beautiful finishes.

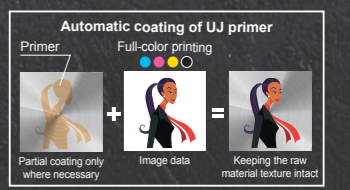

*: Illustrator or Photoshop is required.